

BIXOLON®

Code Pages Manual **Label Printer**

Rev. 1.00

**SLP-D220 / D220E
SLP-D223 / D223E**

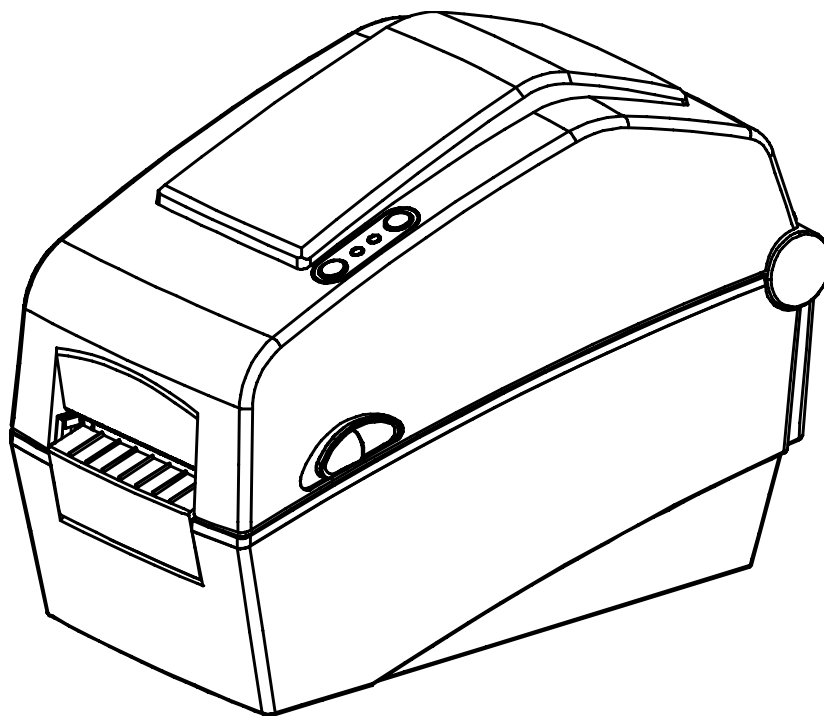

<http://www.bixolon.com>

■ Table of Contents

1. Notice..... 3

2. Code Page 4

0: PC437 (U.S.A)..... 4

1: PC850 (LATIN 1) 5

2: PC852 (LATIN 2) 6

3: PC860 (PORTUGUESE) 7

4: PC863 (CANADIAN FRENCH)..... 8

5: PC865 (NORDIC) 9

6: PC1252 (WINDOWS LATIN 1) 10

7: PC865 + PC1252 (EUROPEAN COMBINED) 11

8: PC857 (TURKISH)..... 12

9: PC737 (GREEK)..... 13

10: PC1250 (WINDOWS LATIN 2) 14

11: PC1253 (GREEK)..... 15

12: PC1254 (TURKISH)..... 16

13: PC855 (CYRILLIC) 17

14: PC862 (HEBREW)..... 18

15: PC866 (CYRILLIC) 19

16: PC1251 (CYRILLIC) 20

17: PC1255 (HEBREW)..... 21

18: PC928 (GREEK)..... 22

19: PC864 (Arabic) 23

20: PC775 (Baltic)..... 24

21: PC1257 (Baltic)..... 25

22: PC858 (Latin 1 + Euro) 26

1. Notice

The following pages show the character code tables. To find the character corresponding to a hexadecimal number, count across the top of the table for the left digit and count down the left column of the table for the right digit.

For example, 4A = J. (Page 0)

We at BIXOLON maintain ongoing efforts to enhance and upgrade the functions and quality of all our products. In following, product specifications and/or user manual content may be changed without prior notice.

2. Code Page

0: PC437 (U.S.A)

128(80h) ~ 255(FF)

HEX	BIN	0	1	2	3	4	5	6	7	8	9	A	B	C	D	E	F
HEX	BIN	0000	0001	0010	0011	0100	0101	0110	0111	1000	1001	1010	1011	1100	1101	1110	1111
0	0000	NUL	DLE	SP	0	@	P	`	p	Ç	É	á	☐	☐	☐	α	☐
		00	16	32	48	64	80	96	112	128	144	160	176	192	208	224	240
1	0001		!	1	A	Q	a	q	ü	æ	í	☐	☐	☐	β	±	
		01	17	33	49	65	81	97	113	129	145	161	177	193	209	225	241
2	0010		"	2	B	R	b	r	é	Æ	ó	☐	☐	☐	Γ	≥	
		02	18	34	50	66	82	98	114	130	146	162	178	194	210	226	242
3	0011		#	3	C	S	c	s	â	ô	ú	☐	☐	☐	π	≤	
		03	19	35	51	67	83	99	115	131	147	163	179	195	211	227	243
4	0100	EOT		\$	4	D	T	d	t	ä	ö	ñ	☐	☐	☐	Σ	f
		04	20	36	52	68	84	100	116	132	148	164	180	196	212	228	244
5	0101	ENQ		%	5	E	U	e	u	à	ò	Ñ	☐	☐	☐	σ	J
		05	21	37	53	69	85	101	117	133	149	165	181	197	213	229	245
6	0110		&	6	F	V	f	v	å	û	ª	☐	☐	☐	μ	÷	
		06	22	38	54	70	86	102	118	134	150	166	182	198	214	230	246
7	0111		'	7	G	W	g	w	ç	ù	º	☐	☐	☐	τ	≈	
		07	23	39	55	71	87	103	119	135	151	167	183	199	215	231	247
8	1000	BS	CAN	(8	H	X	h	x	ê	ÿ	ı	☐	☐	☐	Φ	°
		08	24	40	56	72	88	104	120	136	152	168	184	200	216	232	248
9	1001	HT)	9	I	Y	i	y	ë	Ö	ƒ	☐	☐	☐	θ	•
		09	25	41	57	73	89	105	121	137	153	169	185	201	217	233	249
A	1010	LF		*	:	J	Z	j	z	è	Ü	ƒ	☐	☐	☐	Ω	•
		10	26	42	58	74	90	106	122	138	154	170	186	202	218	234	250
B	1011		ESC	+	;	K	[k	{	ï	ø	1/2	☐	☐	☐	δ	√
		11	27	43	59	75	91	107	123	139	155	171	187	203	219	235	251
C	1100	FF	FS	,	<	L	\	l		î	£	1/4	☐	☐	☐	∞	n
		12	28	44	60	76	92	108	124	140	156	172	188	204	220	236	252
D	1101	CR	GS	-	=	M]	m	}	ì	¥	ı	☐	☐	☐	φ	²
		13	29	45	61	77	93	109	125	141	157	173	189	205	221	237	253
E	1110		.	>	>	N	^	n	~	Ä	Pt	«	☐	☐	☐	ε	•
		14	30	46	62	78	94	110	126	142	158	174	190	206	222	238	254
F	1111		/	?	?	O	_	o	SP	Å	f	»	☐	☐	☐	∩	SP
		15	31	47	63	79	95	111	127	143	159	175	191	207	223	239	255

1: PC850 (LATIN 1)

128(80h) ~ 255(FF)

	HEX	8	9	A	B	C	D	E	F
HEX	BIN	1000	1001	1010	1011	1100	1101	1110	1111
0	0000	Ç 128	É 144	á 160	☐ 176	Ł 192	š 208	Ó 224	— 240
1	0001	ü 129	æ 145	í 161	☐ 177	⊥ 193	Đ 209	β 225	± 241
2	0010	é 130	Æ 146	ó 162	☐ 178	⌣ 194	Ê 210	Ô 226	= 242
3	0011	â 131	ô 147	ú 163	 179	⌣ 195	Ë 211	Ò 227	3/4 243
4	0100	ä 132	ö 148	ñ 164	† 180	— 196	È 212	ö 228	¶ 244
5	0101	à 133	ò 149	Ñ 165	Á 181	+ 197	i 213	Õ 229	§ 245
6	0110	á 134	û 150	ª 166	Â 182	ã 198	í 214	μ 230	÷ 246
7	0111	ç 135	ù 151	º 167	À 183	Ã 199	î 215	þ 231	· 247
8	1000	ê 136	ÿ 152	¿ 168	© 184	Ł 200	ï 216	þ 232	° 248
9	1001	ë 137	Ö 153	® 169	≡ 185	ƒ 201	⌋ 217	Ú 233	¨ 249
A	1010	è 138	Ü 154	¬ 170	∥ 186	⌋ 202	⌈ 218	Û 234	• 250
B	1011	ï 139	ø 155	1/2 171	∩ 187	⌣ 203	■ 219	Ù 235	1 251
C	1100	î 140	£ 156	1/4 172	∩ 188	⌣ 204	■ 220	Ý 236	3 252
D	1101	ì 141	Ø 157	i 173	¢ 189	= 205	ì 221	Ý 237	2 253
E	1110	Ä 142	X 158	« 174	¥ 190	† 206	ì 222	— 238	▪ 254
F	1111	Å 143	f 159	» 175	∩ 191	☉ 207	■ 223	´ 239	SP 255

2: PC852 (LATIN 2)
128(80h) ~ 255(FF)

	HEX	8	9	A	B	C	D	E	F
HEX	BIN	1000	1001	1010	1011	1100	1101	1110	1111
0	0000	Ç 128	É 144	á 160	▣ 176	Ł 192	đ 208	Ó 224	- 240
1	0001	ü 129	Í 145	í 161	▤ 177	ł 193	Đ 209	β 225	“ 241
2	0010	é 130	İ 146	ó 162	▥ 178	ṽ 194	Ď 210	Ô 226	” 242
3	0011	â 131	ô 147	ú 163	 179	† 195	Ě 211	Ń 227	ˇ 243
4	0100	ä 132	ö 148	À 164	┌ 180	— 196	d' 212	ń 228	˘ 244
5	0101	û 133	Ĺ 149	ą 165	Á 181	+ 197	Ň 213	ň 229	§ 245
6	0110	ć 134	Ĳ 150	ž 166	Â 182	Ǻ 198	í 214	š 230	+ 246
7	0111	ç 135	Ś 151	ž 167	Ě 183	ǻ 199	î 215	š 231	˙ 247
8	1000	ı 136	ś 152	Ę 168	Ş 184	Ł 200	ě 216	Ŕ 232	° 248
9	1001	ë 137	Ö 153	ę 169	 185	Ɔ 201	ǰ 217	Ú 233	“ 249
A	1010	Ő 138	Û 154	Ɔ 170	 186	⌌ 202	Ɔ 218	ı 234	· 250
B	1011	ő 139	Ť 155	Ž 171	┐ 187	ṽ 203	■ 219	Ů 235	ů 251
C	1100	î 140	ť 156	Č 172	└ 188	Ɔ 204	■ 220	Ý 236	Ř 252
D	1101	ž 141	ł 157	ş 173	Ž 189	= 205	ṽ 221	Ý 237	ř 253
E	1110	Ǻ 142	x 158	« 174	ž 190	‡ 206	Ů 222	ı 238	■ 254
F	1111	Ć 143	č 159	» 175	┘ 191	α 207	■ 223	· 239	 255

3: PC860 (PORTUGUESE)

128(80h) ~ 255(FF)

	HEX	8	9	A	B	C	D	E	F
HEX	BIN	1000	1001	1010	1011	1100	1101	1110	1111
0	0000	Ç 128	É 144	á 160	☐ 176	┌ 192	⌌ 208	α 224	≡ 240
1	0001	ü 129	À 145	í 161	☐ 177	┐ 193	⌍ 209	β 225	± 241
2	0010	é 130	È 146	ó 162	☐ 178	└ 194	⌎ 210	Γ 226	≥ 242
3	0011	â 131	ô 147	ú 163	 179	┘ 195	⌏ 211	π 227	≤ 243
4	0100	ã 132	õ 148	ñ 164	┌ 180	— 196	┐ 212	Σ 228	f 244
5	0101	à 133	ò 149	Ñ 165	≡ 181	÷ 197	ƒ 213	σ 229	J 245
6	0110	Á 134	Ú 150	ã 166	≡ 182	ƒ 198	ƒ 214	μ 230	÷ 246
7	0111	ç 135	ù 151	œ 167	≡ 183	ƒ 199	≡ 215	τ 231	≈ 247
8	1000	ê 136	ì 152	¿ 168	≡ 184	┌ 200	≡ 216	Φ 232	° 248
9	1001	Ê 137	Õ 153	Ò 169	≡ 185	┐ 201	┘ 217	θ 233	• 249
A	1010	è 138	Ü 154	¬ 170	≡ 186	⌌ 202	┐ 218	Ω 234	• 250
B	1011	í 139	ç 155	1/2 171	≡ 187	≡ 203	■ 219	δ 235	√ 251
C	1100	Ô 140	£ 156	1/4 172	≡ 188	≡ 204	■ 220	∞ 236	n 252
D	1101	ì 141	Ù 157	i 173	≡ 189	= 205	■ 221	φ 237	² 253
E	1110	Ã 142	Pt 158	« 174	≡ 190	≡ 206	■ 222	ε 238	▪ 254
F	1111	Â 143	Ó 159	» 175	┐ 191	± 207	■ 223	∩ 239	SP 255

4: PC863 (CANADIAN FRENCH)

128(80h) ~ 255(FF)

	HEX	8	9	A	B	C	D	E	F
HEX	BIN	1000	1001	1010	1011	1100	1101	1110	1111
0	0000	Ç 128	É 144	Ï 160	Ë 176	Ł 192	Ǽ 208	α 224	≡ 240
1	0001	ü 129	È 145	‘ 161	Ï 177	Ł 193	Ǽ 209	β 225	± 241
2	0010	é 130	Ê 146	ó 162	Ë 178	Ł 194	Ǽ 210	Γ 226	≥ 242
3	0011	â 131	ô 147	ú 163	Ï 179	Ł 195	Ǽ 211	π 227	≤ 243
4	0100	Â 132	Ë 148	“ 164	Ï 180	Ł 196	Ǽ 212	Σ 228	f 244
5	0101	à 133	ï 149	• 165	Ï 181	Ł 197	Ǽ 213	σ 229	Ƶ 245
6	0110	¶ 134	û 150	³ 166	Ï 182	Ł 198	Ǽ 214	μ 230	÷ 246
7	0111	ç 135	ù 151	— 167	Ï 183	Ł 199	Ǽ 215	τ 231	≈ 247
8	1000	ê 136	œ 152	î 168	Ï 184	Ł 200	Ǽ 216	Φ 232	° 248
9	1001	è 137	Ô 153	ƒ 169	Ï 185	Ł 201	Ǽ 217	θ 233	• 249
A	1010	ê 138	Ü 154	ƒ 170	Ï 186	Ł 202	Ǽ 218	Ω 234	• 250
B	1011	ï 139	ø 155	1/2 171	Ï 187	Ł 203	■ 219	δ 235	√ 251
C	1100	î 140	£ 156	1/4 172	Ï 188	Ł 204	■ 220	∞ 236	n 252
D	1101	= 141	Ù 157	3/4 173	Ï 189	Ł 205	■ 221	φ 237	² 253
E	1110	À 142	Ô 158	« 174	Ï 190	Ł 206	■ 222	ε 238	▪ 254
F	1111	§ 143	f 159	» 175	Ï 191	Ł 207	■ 223	∩ 239	SP 255

5: PC865 (NORDIC)
128(80h) ~ 255(FF)

	HEX	8	9	A	B	C	D	E	F
HEX	BIN	1000	1001	1010	1011	1100	1101	1110	1111
0	0000	Ç 128	É 144	á 160	☐ 176	Ł 192	⌌ 208	α 224	≡ 240
1	0001	Û 129	æ 145	í 161	☐ 177	⊥ 193	⌌ 209	β 225	± 241
2	0010	é 130	Æ 146	ó 162	☐ 178	⌌ 194	⌌ 210	Γ 226	≥ 242
3	0011	â 131	ô 147	ú 163	 179	⌌ 195	⌌ 211	π 227	≤ 243
4	0100	ä 132	ö 148	ñ 164	⌌ 180	— 196	⌌ 212	Σ 228	f 244
5	0101	à 133	ò 149	Ñ 165	⌌ 181	⌌ 197	⌌ 213	σ 229	J 245
6	0110	å 134	û 150	ä 166	⌌ 182	⌌ 198	⌌ 214	μ 230	÷ 246
7	0111	ç 135	ù 151	œ 167	⌌ 183	⌌ 199	⌌ 215	τ 231	≈ 247
8	1000	ê 136	ÿ 152	¿ 168	⌌ 184	⌌ 200	⌌ 216	Φ 232	° 248
9	1001	ë 137	Ö 153	⌌ 169	⌌ 185	⌌ 201	⌌ 217	θ 233	• 249
A	1010	è 138	Ü 154	⌌ 170	⌌ 186	⌌ 202	⌌ 218	Ω 234	• 250
B	1011	ï 139	ø 155	1/2 171	⌌ 187	⌌ 203	■ 219	δ 235	√ 251
C	1100	î 140	£ 156	1/4 172	⌌ 188	⌌ 204	■ 220	∞ 236	n 252
D	1101	ì 141	Ø 157	i 173	⌌ 189	= 205	■ 221	φ 237	² 253
E	1110	Ä 142	Pt 158	« 174	⌌ 190	⌌ 206	■ 222	ε 238	▪ 254
F	1111	Å 143	f 159	⌌ 175	⌌ 191	⌌ 207	■ 223	∩ 239	SP 255

6: PC1252 (WINDOWS LATIN 1)
128(80h) ~ 255(FF)

	HEX	8	9	A	B	C	D	E	F
HEX	BIN	1000	1001	1010	1011	1100	1101	1110	1111
0	0000	€ 128			° 176	À 192	Ð 208	à 224	đ 240
1	0001		‘ 144	í 161	± 177	Á 193	Ñ 209	á 225	ñ 241
2	0010	, 130	, 146	¢ 162	2 178	Â 194	Ò 210	â 226	ò 242
3	0011	f 131	“ 147	£ 163	3 179	Ã 195	Ó 211	ã 227	ó 243
4	0100	” 132	” 148	¤ 164	´ 180	Ä 196	Ô 212	ä 228	ô 244
5	0101	… 133	• 149	¥ 165	µ 181	Å 197	Ö 213	å 229	ö 245
6	0110	† 134	- 150	 166	¶ 182	Æ 198	Ø 214	æ 230	ø 246
7	0111	‡ 135	– 151	§ 167	• 183	Ç 199	× 215	ç 231	÷ 247
8	1000	^ 136	~ 152	¨ 168	˙ 184	È 200	Ø 216	è 232	ø 248
9	1001	‰ 137	™ 153	© 169	1 185	É 201	Ù 217	é 233	ù 249
A	1010	Š 138	š 154	à 170	ó 186	Ê 202	Ú 218	ê 234	ú 250
B	1011	‹ 139	› 155	« 171	» 187	Ë 203	Û 219	ë 235	û 251
C	1100	Œ 140	œ 156	¬ 172	¼ 188	Ì 204	Ü 220	ì 236	ü 252
D	1101			- 173	½ 189	Í 205	Ý 221	í 237	ý 253
E	1110	Ž 142	ž 158	® 174	¾ 190	Î 206	Þ 222	î 238	þ 254
F	1111		ÿ 159	- 175	¿ 191	Ï 207	ß 223	ï 239	ÿ 255

7: PC865 + PC1252 (EUROPEAN COMBINED)

0x80 : Euro Currency, 0x81~0x9f : PC865, 0xA0~0xFF : PC1252



	HEX	8	9	A	B	C	D	E	F
HEX	BIN	1000	1001	1010	1011	1100	1101	1110	1111
0	0000	Ç 128	É 144		° 176	À 192	Ð 208	à 224	ð 240
1	0001	ü 129	æ 145	ı 161	± 177	Á 193	Ñ 209	á 225	ñ 241
2	0010	é 130	Æ 146	¢ 162	² 178	Â 194	Ò 210	â 226	ò 242
3	0011	â 131	ô 147	£ 163	³ 179	Ã 195	Ó 211	ã 227	ó 243
4	0100	ä 132	ö 148	¤ 164	´ 180	Ä 196	Ô 212	ä 228	ô 244
5	0101	à 133	ò 149	¥ 165	µ 181	Å 197	Õ 213	å 229	õ 245
6	0110	å 134	û 150	 166	¶ 182	Æ 198	Ö 214	æ 230	ö 246
7	0111	ç 135	ù 151	§ 167	· 183	Ç 199	× 215	ç 231	÷ 247
8	1000	ê 136	ï 152	¨ 168	, 184	È 200	Ø 216	è 232	ø 248
9	1001	ë 137	Ï 153	© 169	¹ 185	É 201	Ù 217	é 233	ù 249
A	1010	è 138	Û 154	ª 170	º 186	Ê 202	Ú 218	ê 234	ú 250
B	1011	ï 139	ø 155	« 171	» 187	Ë 203	Û 219	ë 235	û 251
C	1100	î 140	£ 156	¬ 172	¼ 188	Ì 204	Ü 220	ì 236	ü 252
D	1101	ı 141	Ø 157	- 173	½ 189	Í 205	Ý 221	í 237	ý 253
E	1110	Ä 142	ƒ 158	® 174	¾ 190	Î 206	Ɔ 222	î 238	Ɔ 254
F	1111	Å 143	f 159	— 175	¿ 191	Ï 207	ß 223	ï 239	

8: PC857 (TURKISH)
128(80h) ~ 255(FF)

	HEX	8	9	A	B	C	D	E	F
HEX	BIN	1000	1001	1010	1011	1100	1101	1110	1111
0	0000	Ç 128	É 144	á 160	☐ 176	L 192	° 208	Ó 224	- 240
1	0001	ü 129	æ 145	í 161	☐ 177	⊥ 193	ª 209	ß 225	± 241
2	0010	é 130	Æ 146	ó 162	☐ 178	⊥ 194	Ê 210	Ô 226	
3	0011	â 131	ô 147	ú 163	 179	⊥ 195	Ë 211	Ò 227	¾ 243
4	0100	ä 132	ö 148	ñ 164	⊥ 180	- 196	È 212	õ 228	¶ 244
5	0101	à 133	ò 149	Ñ 165	Á 181	⊥ 197		Õ 229	§ 245
6	0110	â 134	û 150	Ğ 166	Â 182	ã 198	Í 214	µ 230	÷ 246
7	0111	ç 135	ù 151	ğ 167	À 183	Ã 199	Î 215		· 247
8	1000	ê 136	İ 152	ı 168	© 184	℔ 200	Ï 216	× 232	° 248
9	1001	ë 137	Ö 153	® 169	≡ 185	℔ 201	⌋ 217	Ú 233	¨ 249
A	1010	è 138	Ü 154	¬ 170	≡ 186	≡ 202	⌈ 218	Û 234	· 250
B	1011	ï 139	ø 155	½ 171	⌋ 187	⌋ 203	■ 219	Ù 235	¹ 251
C	1100	î 140	£ 156	¼ 172	⌋ 188	⌋ 204	■ 220	ì 236	³ 252
D	1101	ı 141	Ø 157	ı 173	é 189	= 205	ı 221	ÿ 237	² 253
E	1110	Ä 142	Ş 158	« 174	¥ 190	≡ 206	İ 222	- 238	■ 254
F	1111	Å 143	ş 159	» 175	⌈ 191	○ 207	■ 223	´ 239	

9: PC737 (GREEK)

128(80h) ~ 255(FF)

	HEX	8	9	A	B	C	D	E	F
HEX	BIN	1000	1001	1010	1011	1100	1101	1110	1111
0	0000	Α 128	Ρ 144	ι 160	 176	Λ 192	⊥ 208	ω 224	Ω 240
1	0001	Β 129	Σ 145	κ 161	 177	⊥ 193	⊥ 209	ά 225	± 241
2	0010	Γ 130	Τ 146	λ 162	 178	⊥ 194	⊥ 210	έ 226	≥ 242
3	0011	Δ 131	Υ 147	μ 163	 179	⊥ 195	⊥ 211	ή 227	≤ 243
4	0100	Ε 132	Φ 148	ν 164	⊥ 180	— 196	⊥ 212	ϊ 228	Ï 244
5	0101	Ζ 133	Χ 149	ξ 165	⊥ 181	⊥ 197	⊥ 213	ί 229	ÿ 245
6	0110	Η 134	Ψ 150	ο 166	⊥ 182	⊥ 198	⊥ 214	ό 230	÷ 246
7	0111	Θ 135	Ω 151	π 167	⊥ 183	⊥ 199	⊥ 215	ύ 231	≈ 247
8	1000	Ι 136	α 152	ρ 168	⊥ 184	⊥ 200	⊥ 216	ϋ 232	° 248
9	1001	Κ 137	β 153	σ 169	⊥ 185	⊥ 201	⊥ 217	ώ 233	· 249
A	1010	Λ 138	γ 154	ς 170	⊥ 186	⊥ 202	⊥ 218	Ά 234	· 250
B	1011	Μ 139	δ 155	τ 171	⊥ 187	⊥ 203	■ 219	Έ 235	√ 251
C	1100	Ν 140	ε 156	υ 172	⊥ 188	⊥ 204	■ 220	Η 236	ñ 252
D	1101	Ξ 141	ζ 157	φ 173	⊥ 189	⊥ 205	■ 221	Ί 237	² 253
E	1110	Ο 142	η 158	χ 174	⊥ 190	⊥ 206	■ 222	Ό 238	■ 254
F	1111	Π 143	θ 159	ψ 175	⊥ 191	⊥ 207	■ 223	Υ 239	SP 255

10: PC1250 (WINDOWS LATIN 2)

128(80h) ~ 255(FF)

	HEX	8	9	A	B	C	D	E	F
HEX	BIN	1000	1001	1010	1011	1100	1101	1110	1111
0	0000	€ 128		NBSP 160	° 176	Ŕ 192	Đ 208	ř 224	ď 240
1	0001		‘ 145	˘ 161	± 177	Á 193	Ń 209	á 225	ń 241
2	0010	, 130	, 146	˘ 162	˘ 178	Ā 194	Ň 210	â 226	ň 242
3	0011	f 131	“ 147	£ 163	† 179	Ā 195	Ó 211	ǎ 227	ó 243
4	0100	” 132	” 148	α 164	˘ 180	Ä 196	Ö 212	ä 228	ö 244
5	0101	… 133	• 149	Α 165	μ 181	Ĺ 197	Õ 213	Í 229	ő 245
6	0110	† 134	— 150	ı 166	¶ 182	Ć 198	Ö 214	ć 230	ö 246
7	0111	‡ 135	— 151	§ 167	· 183	Ç 199	× 215	ç 231	÷ 247
8	1000	^ 136	~ 152	¨ 168	˘ 184	Č 200	Ř 216	č 232	ř 248
9	1001	‰ 137	™ 153	© 169	ą 185	É 201	Û 217	é 233	ű 249
A	1010	Š 138	š 154	Ş 170	ş 186	Ę 202	Ú 218	ę 234	ú 250
B	1011	< 139	> 155	« 171	» 187	Ě 203	Ů 219	ě 235	ů 251
C	1100	Š 140	š 156	¬ 172	Ł 188	Ě 204	Ü 220	ě 236	ü 252
D	1101	Ť 141	t' 157	- 173	" 189	Í 205	Ý 221	í 237	ý 253
E	1110	Ž 142	ž 158	® 174	ł 190	Î 206	Ț 222	î 238	ł 254
F	1111	Ž 143	ž 159	Ž 175	ż 191	Ď 207	ß 223	ď 239	· 255

11: PC1253 (GREEK)

128(80h) ~ 255(FF)

	HEX	8	9	A	B	C	D	E	F
HEX	BIN	1000	1001	1010	1011	1100	1101	1110	1111
0	0000	€ 128		NBSP 160	° 176	ı̇ 192	Π 208	ö 224	π 240
1	0001		‘ 145	” 161	± 177	Α 193	Ρ 209	α 225	ρ 241
2	0010	, 130	, 146	À 162	² 178	Β 194		β 226	ς 242
3	0011	<i>f</i> 131	“ 147	£ 163	³ 179	Γ 195	Σ 211	ϣ 227	ο 243
4	0100	” 132	” 148	α 164	’ 180	Δ 196	Τ 212	δ 228	τ 244
5	0101	… 133	• 149	¥ 165	μ 181	Ε 197	Υ 213	ε 229	υ 245
6	0110	† 134	— 150	ı̇ 166	¶ 182	Ζ 198	Φ 214	ζ 230	φ 246
7	0111	‡ 135	— 151	§ 167	· 183	Η 199	Χ 215	η 231	χ 247
8	1000			” 168	Ε 184	Θ 200	Ψ 216	Θ 232	Ψ 248
9	1001	‰ 137	™ 153	© 169	Η 185	Ι 201	Ω 217	ι 233	ω 249
A	1010				Ι 186	Κ 202	Ï 218	κ 234	ï 250
B	1011	< 139	> 155	« 171	» 187	Λ 203	ÿ 219	λ 235	ÿ 251
C	1100			¬ 172	Ό 188	Μ 204	ά 220	μ 236	ό 252
D	1101			- 173	½ 189	Ν 205	έ 221	ν 237	ύ 253
E	1110			® 174	Υ 190	Ξ 206	ή 222	ξ 238	ώ 254
F	1111			— 175	Ω 191	Ο 207	ι 223	ο 239	

12: PC1254 (TURKISH)
128(80h) ~ 255(FF)

	HEX	8	9	A	B	C	D	E	F
HEX	BIN	1000	1001	1010	1011	1100	1101	1110	1111
0	0000	€ 128		NBSP 160	° 176	À 192	Ğ 208	à 224	ğ 240
1	0001		‘ 145	ı 161	± 177	Á 193	Ñ 209	á 225	ñ 241
2	0010	, 130	, 146	¢ 162	² 178	Â 194	Ò 210	â 226	ò 242
3	0011	f 131	“ 147	£ 163	³ 179	Ã 195	Ó 211	ã 227	ó 243
4	0100	” 132	” 148	¤ 164	´ 180	Ä 196	Ô 212	ä 228	ô 244
5	0101	… 133	• 149	¥ 165	µ 181	Å 197	Õ 213	å 229	õ 245
6	0110	† 134	– 150	ı 166	¶ 182	Æ 198	Ö 214	æ 230	ö 246
7	0111	‡ 135	— 151	§ 167	· 183	Ç 199	× 215	ç 231	÷ 247
8	1000	^ 136	~ 152	¨ 168	¸ 184	È 200	Ø 216	è 232	ø 248
9	1001	‰ 137	™ 153	© 169	¹ 185	É 201	Ù 217	é 233	ù 249
A	1010	Š 138	š 154	ª 170	º 186	Ê 202	Ú 218	ê 234	ú 250
B	1011	< 139	> 155	« 171	» 187	Ë 203	Û 219	ë 235	û 251
C	1100	Œ 140	œ 156	¬ 172	¼ 188	Ì 204	Ü 220	ì 236	ü 252
D	1101			- 173	½ 189	Í 205	İ 221	í 237	ı 253
E	1110			® 174	¾ 190	Î 206	Ş 222	î 238	ş 254
F	1111		ÿ 159	¯ 175	¿ 191	Ï 207	ß 223	ï 239	ÿ 255



13: PC855 (CYRILLIC)
128(80h) ~ 255(FF)

	HEX	8	9	A	B	C	D	E	F
HEX	BIN	1000	1001	1010	1011	1100	1101	1110	1111
0	0000	ђ 128	љ 144	а 160	▒ 176	Љ 192	Л 208	Я 224	- 240
1	0001	Ђ 129	Љ 145	А 161	▒ 177	Љ 193	Л 209	Р 225	Ы 241
2	0010	ѓ 130	њ 146	б 162	▒ 178	Т 194	М 210	Р 226	Ы 242
3	0011	Ђ 131	Њ 147	Б 163	 179	Т 195	М 211	С 227	З 243
4	0100	ё 132	ђ 148	ц 164	† 180	— 196	Н 212	С 228	З 244
5	0101	Ё 133	Ђ 149	Ц 165	х 181	† 197	Н 213	Т 229	Ш 245
6	0110	е 134	ќ 150	д 166	Х 182	К 198	О 214	Т 230	Ш 246
7	0111	Є 135	Ќ 151	Д 167	и 183	К 199	О 215	У 231	Э 247
8	1000	ѕ 136	ђ 152	е 168	И 184	Љ 200	П 216	У 232	Э 248
9	1001	Ѕ 137	Ђ 153	Е 169	 185	Љ 201	П 217	Ж 233	Щ 249
A	1010	і 138	ц 154	ф 170	 186	Љ 202	Г 218	Ж 234	Щ 250
B	1011	І 139	Ц 155	Ф 171	 187	Љ 203	■ 219	В 235	Ч 251
C	1100	ї 140	ю 156	Г 172	 188	Љ 204	■ 220	В 236	Ч 252
D	1101	Ї 141	Ю 157	Г 173	й 189	= 205	П 221	Ь 237	§ 253
E	1110	ј 142	ъ 158	« 174	Й 190	 206	Я 222	Ь 238	■ 254
F	1111	Ј 143	Ъ 159	» 175	Г 191	Ѧ 207	■ 223	№ 239	 255

14: PC862 (HEBREW)
128(80h) ~ 255(FF)

	HEX	8	9	A	B	C	D	E	F
HEX	BIN	1000	1001	1010	1011	1100	1101	1110	1111
0	0000	א 128	ב 144	א 160	א 176	א 192	א 208	א 224	א 240
1	0001	ב 129	ב 145	ב 161	ב 177	ב 193	ב 209	ב 225	ב 241
2	0010	ג 130	ג 146	ג 162	ג 178	ג 194	ג 210	ג 226	ג 242
3	0011	ד 131	ד 147	ד 163	ד 179	ד 195	ד 211	ד 227	ד 243
4	0100	ה 132	ה 148	ה 164	ה 180	ה 196	ה 212	ה 228	ה 244
5	0101	ו 133	ו 149	ו 165	ו 181	ו 197	ו 213	ו 229	ו 245
6	0110	ז 134	ז 150	ז 166	ז 182	ז 198	ז 214	ז 230	ז 246
7	0111	ח 135	ח 151	ח 167	ח 183	ח 199	ח 215	ח 231	ח 247
8	1000	ט 136	ט 152	ט 168	ט 184	ט 200	ט 216	ט 232	ט 248
9	1001	י 137	י 153	י 169	י 185	י 201	י 217	י 233	י 249
A	1010	כ 138	כ 154	כ 170	כ 186	כ 202	כ 218	כ 234	כ 250
B	1011	כ 139	כ 155	כ 171	כ 187	כ 203	כ 219	כ 235	כ 251
C	1100	ל 140	ל 156	ל 172	ל 188	ל 204	ל 220	ל 236	ל 252
D	1101	מ 141	מ 157	מ 173	מ 189	מ 205	מ 221	מ 237	מ 253
E	1110	נ 142	נ 158	נ 174	נ 190	נ 206	נ 222	נ 238	נ 254
F	1111	ס 143	ס 159	ס 175	ס 191	ס 207	ס 223	ס 239	ס 255

15: PC866 (CYRILLIC)
128(80h) ~ 255(FF)

	HEX	8	9	A	B	C	D	E	F
HEX	BIN	1000	1001	1010	1011	1100	1101	1110	1111
0	0000	А 128	Р 144	а 160	 176	Л 192	⊥ 208	р 224	Ё 240
1	0001	Б 129	С 145	б 161	 177	⊥ 193	⊥ 209	с 225	ё 241
2	0010	В 130	Т 146	в 162	 178	⊥ 194	⊥ 210	т 226	ѐ 242
3	0011	Г 131	У 147	г 163	 179	⊥ 195	⊥ 211	у 227	ѓ 243
4	0100	Д 132	Ф 148	д 164	⊥ 180	— 196	⊥ 212	ф 228	ї 244
5	0101	Е 133	Х 149	е 165	⊥ 181	⊥ 197	⊥ 213	х 229	і 245
6	0110	Ж 134	Ц 150	ж 166	⊥ 182	⊥ 198	⊥ 214	ц 230	ÿ 246
7	0111	З 135	Ч 151	з 167	⊥ 183	⊥ 199	⊥ 215	ч 231	ÿ 247
8	1000	И 136	Ш 152	и 168	⊥ 184	⊥ 200	⊥ 216	ш 232	° 248
9	1001	Й 137	Щ 153	й 169	⊥ 185	⊥ 201	⊥ 217	щ 233	· 249
A	1010	К 138	Ъ 154	к 170	 186	⊥ 202	⊥ 218	ъ 234	· 250
B	1011	Л 139	Ы 155	л 171	⊥ 187	⊥ 203	■ 219	ы 235	√ 251
C	1100	М 140	Ь 156	м 172	⊥ 188	⊥ 204	■ 220	ь 236	№ 252
D	1101	Н 141	Э 157	н 173	⊥ 189	⊥ 205	■ 221	э 237	¤ 253
E	1110	О 142	Ю 158	о 174	⊥ 190	⊥ 206	■ 222	ю 238	■ 254
F	1111	П 143	Я 159	п 175	⊥ 191	⊥ 207	■ 223	я 239	SP 255

16: PC1251 (CYRILLIC)

128(80h) ~ 255(FF)

	HEX	8	9	A	B	C	D	E	F
HEX	BIN	1000	1001	1010	1011	1100	1101	1110	1111
0	0000	Ҫ 128	Ҫ 144	NBSP 160	° 176	А 192	Р 208	а 224	р 240
1	0001	Ѓ 129	‘ 145	Ў 161	± 177	Б 193	С 209	б 225	с 241
2	0010	, 130	, 146	Ў 162	І 178	В 194	Т 210	В 226	Т 242
3	0011	Ѓ 131	“ 147	Ј 163	і 179	Г 195	У 211	Г 227	у 243
4	0100	” 132	” 148	Ѡ 164	Г 180	Д 196	Ф 212	д 228	ф 244
5	0101	… 133	• 149	Г 165	μ 181	Е 197	Х 213	е 229	х 245
6	0110	† 134	— 150	І 166	¶ 182	Ж 198	Ц 214	ж 230	ц 246
7	0111	‡ 135	— 151	§ 167	· 183	З 199	Ч 215	з 231	ч 247
8	1000	€ 136	™ 152	Ё 168	ё 184	И 200	Ш 216	и 232	ш 248
9	1001	‰ 137	™ 153	© 169	№ 185	Й 201	Щ 217	й 233	щ 249
A	1010	Љ 138	Љ 154	Є 170	є 186	К 202	Ъ 218	к 234	ъ 250
B	1011	‘ 139	’ 155	« 171	» 187	Л 203	Ы 219	л 235	ы 251
C	1100	Ҫ 140	Ҫ 156	¬ 172	ј 188	М 204	Ь 220	м 236	ь 252
D	1101	Ѓ 141	Ѓ 157	- 173	ѕ 189	Н 205	Э 221	н 237	э 253
E	1110	Ҫ 142	Ҫ 158	® 174	ѕ 190	О 206	Ю 222	о 238	ю 254
F	1111	Ц 143	Ц 159	İ 175	ï 191	П 207	Я 223	п 239	я 255

17: PC1255 (HEBREW)

128(80h) ~ 255(FF)

	HEX	8	9	A	B	C	D	E	F
HEX	BIN	1000	1001	1010	1011	1100	1101	1110	1111
0	0000	€ 128		NBSP 160	° 176	· 192	 208	א 224	ן 240
1	0001		‘ 145	ì 161	± 177	“ 193	· 209	ב 225	ס 241
2	0010	, 130	, 146	¢ 162	² 178	“ 194	· 210	ג 226	ע 242
3	0011	f 131	“ 147	£ 163	³ 179	“ 195	: 211	ד 227	ף 243
4	0100	” 132	” 148	₪ 164	’ 180	· 196	ן 212	ה 228	פ 244
5	0101	… 133	• 149	¥ 165	μ 181	“ 197	ך 213	ו 229	ץ 245
6	0110	† 134	– 150	ı 166	¶ 182	“ 198	” 214	ז 230	צ 246
7	0111	‡ 135	— 151	§ 167	· 183	· 199	’ 215	ח 231	ק 247
8	1000	^ 136	~ 152	“ 168	ˆ 184	ˆ 200	” 216	ט 232	ך 248
9	1001	‰ 137	™ 153	© 169	¹ 185	· 201	· 217	י 233	ש 249
A	1010			× 170	÷ 186			ך 234	ת 250
B	1011	< 139	> 155	« 171	» 187	“ 203		כ 235	
C	1100			¬ 172	¼ 188	· 204		ל 236	
D	1101			- 173	½ 189	· 205		ם 237	LTR 253
E	1110			® 174	¾ 190	· 206		נ 238	RTL 254
F	1111			— 175	¿ 191	· 207		ן 239	

18: PC928 (GREEK)

128(80h) ~ 255(FF)

	HEX	8	9	A	B	C	D	E	F
HEX	BIN	1000	1001	1010	1011	1100	1101	1110	1111
0	0000	128	144	160	176	192	208	224	240
1	0001	129	145	161	177	193	209	225	241
2	0010	130	146	162	178	194	210	226	242
3	0011	131	147	163	179	195	211	227	243
4	0100	132	148	164	180	196	212	228	244
5	0101	133	149	165	181	197	213	229	245
6	0110	134	150	166	182	198	214	230	246
7	0111	135	151	167	183	199	215	231	247
8	1000	136	152	168	184	200	216	232	248
9	1001	137	153	169	185	201	217	233	249
A	1010	138	154	170	186	202	218	234	250
B	1011	139	155	171	187	203	219	235	251
C	1100	140	156	172	188	204	220	236	252
D	1101	141	157	173	189	205	221	237	253
E	1110	142	158	174	190	206	222	238	254
F	1111	143	159	175	191	207	223	239	255

19: PC864 (Arabic)

128(80h) ~ 255(FF)

	HEX	8	9	A	B	C	D	E	F
HEX	BIN	1000	1001	1010	1011	1100	1101	1110	1111
0	0000	° 128	β 144	NBSP 160	· 176	¢ 192	ذ 208	- 224	ـ 240
1	0001	· 129	∞ 145	— 161	ٲ 177	ء 193	ر 209	ف 225	ـ 241
2	0010	· 130	∅ 146	آ 162	ٲ 178	آ 194	ز 210	ق 226	ن 242
3	0011	√ 131	± 147	£ 163	ٲ 179	أ 195	س 211	ك 227	ه 243
4	0100	▒ 132	½ 148	¤ 164	ع 180	ؤ 196	ش 212	ل 228	ه 244
5	0101	— 133	¼ 149	أ 165	ه 181	ع 197	ص 213	م 229	ي 245
6	0110	 134	≈ 150	— 166	ٲ 182	ئ 198	ض 214	ن 230	ي 246
7	0111	⊕ 135	« 151	€ 167	ٲ 183	ا 199	ط 215	ه 231	ذ 247
8	1000	⊕ 136	» 152	ا 168	ٲ 184	ب 200	ظ 216	و 232	ق 248
9	1001	⊕ 137	لأ 153	ب 169	ٲ 185	ة 201	ع 217	ي 233	لأ 249
A	1010	⊕ 138	لأ 154	ت 170	ف 186	ت 202	غ 218	ي 234	لأ 250
B	1011	⊕ 139	— 155	ث 171	؛ 187	ث 203	ا 219	ض 235	ل 251
C	1100	⊕ 140	— 156	، 172	س 188	ج 204	⊕ 220	ع 236	ك 252
D	1101	⊕ 141	لا 157	ج 173	ش 189	ح 205	÷ 221	غ 237	ي 253
E	1110	⊕ 142	لا 158	ح 174	ص 190	خ 206	× 222	غ 238	■ 254
F	1111	⊕ 143	لا 159	خ 175	؟ 191	د 207	ع 223	م 239	— 255

20: PC775 (Baltic)

128(80h) ~ 255(FF)

	HEX	8	9	A	B	C	D	E	F
HEX	BIN	1000	1001	1010	1011	1100	1101	1110	1111
0	0000	Ć 128	É 144	Ā 160	▒ 176	Ł 192	ą 208	Ó 224	- 240
1	0001	ü 129	æ 145	Ī 161	▒ 177	ł 193	č 209	ß 225	± 241
2	0010	é 130	Æ 146	ó 162	▒ 178	ṽ 194	ę 210	Ō 226	“ 242
3	0011	ā 131	ō 147	ž 163	 179	ł 195	è 211	Ń 227	¾ 243
4	0100	ä 132	ö 148	ž 164	┘ 180	— 196	ì 212	õ 228	¶ 244
5	0101	ğ 133	Ĝ 149	ž 165	À 181	† 197	š 213	Õ 229	§ 245
6	0110	ą 134	ç 150	” 166	Č 182	Ų 198	ų 214	μ 230	÷ 246
7	0111	ć 135	Ś 151	ı 167	Ę 183	Ū 199	ū 215	ń 231	” 247
8	1000	ł 136	ś 152	© 168	Ę 184	Ł 200	ż 216	Ɔ 232	° 248
9	1001	ē 137	Ö 153	® 169	Ɔ 185	Ŧ 201	ł 217	Ɔ 233	· 249
A	1010	Ŕ 138	Ü 154	¬ 170	 186	Ł 202	ł 218	Ł 234	· 250
B	1011	ŕ 139	ø 155	½ 171	┘ 187	ł 203	■ 219	ł 235	¹ 251
C	1100	ī 140	£ 156	¼ 172	┘ 188	ł 204	■ 220	ŋ 236	³ 252
D	1101	ž 141	Ø 157	ł 173	ł 189	ł 205	■ 221	Ę 237	² 253
E	1110	Ä 142	× 158	« 174	Š 190	ł 206	■ 222	Ń 238	■ 254
F	1111	Å 143	α 159	» 175	┘ 191	Ž 207	■ 223	’ 239	SP 255

21: PC1257 (Baltic)

128(80h) ~ 255(FF)

	HEX	8	9	A	B	C	D	E	F
HEX	BIN	1000	1001	1010	1011	1100	1101	1110	1111
0	0000	€ 128		NBSP 160	° 176	À 192	Š 208	ą 224	š 240
1	0001		‘ 145		± 177	Ĳ 193	Ń 209	į 225	ń 241
2	0010	, 130	, 146	¢ 162	² 178	Ā 194	Ņ 210	ā 226	ņ 242
3	0011		“ 147	£ 163	³ 179	Ć 195	Ó 211	ć 227	ó 243
4	0100	” 132	” 148	¤ 164	´ 180	Ä 196	Ō 212	ä 228	ō 244
5	0101	… 133	• 149		μ 181	Å 197	Õ 213	å 229	õ 245
6	0110	† 134	– 150	ı 166	¶ 182	Ę 198	Ö 214	ę 230	ö 246
7	0111	‡ 135	— 151	§ 167	· 183	Ě 199	× 215	ě 231	÷ 247
8	1000			Ø 168	ø 184	Č 200	Ų 216	č 232	ų 248
9	1001	‰ 137	™ 153	© 169	¹ 185	É 201	Ł 217	é 233	ł 249
A	1010			Ŕ 170	ŗ 186	Ž 202	Ś 218	ż 234	ś 250
B	1011	< 139	> 155	« 171	» 187	Ě 203	Ū 219	è 235	ū 251
C	1100			¬ 172	¼ 188	Ģ 204	Ü 220	ģ 236	ü 252
D	1101	¨ 141	— 157	- 173	½ 189	Ķ 205	Ž 221	ķ 237	ž 253
E	1110	˘ 142	˘ 158	® 174	¾ 190	Ī 206	Ž 222	ī 238	ž 254
F	1111	˙ 143		Æ 175	æ 191	Ļ 207	ß 223	ļ 239	· 255

22: PC858 (Latin 1 + Euro)

128(80h) ~ 255(FF)

	HEX	8	9	A	B	C	D	E	F
HEX	BIN	1000	1001	1010	1011	1100	1101	1110	1111
0	0000	Ç 128	É 144	á 160	☐ 176	Ł 192	ö 208	ó 224	— 240
1	0001	ü 129	æ 145	í 161	☐ 177	⊥ 193	ð 209	β 225	± 241
2	0010	é 130	Æ 146	ó 162	☐ 178	⊥ 194	È 210	ò 226	= 242
3	0011	â 131	ô 147	ú 163	 179	⊥ 195	Ë 211	ò 227	3/4 243
4	0100	ä 132	ö 148	ñ 164	⊥ 180	— 196	È 212	õ 228	¶ 244
5	0101	à 133	ò 149	Ñ 165	Á 181	+ 197	€ 213	Õ 229	§ 245
6	0110	á 134	û 150	a 166	À 182	ã 198	í 214	μ 230	÷ 246
7	0111	ç 135	ù 151	o 167	À 183	Ä 199	↑ 215	þ 231	· 247
8	1000	ê 136	ÿ 152	¿ 168	© 184	Ł 200	↑ 216	þ 232	° 248
9	1001	ë 137	ö 153	® 169	≡ 185	ƒ 201	┘ 217	ú 233	· 249
A	1010	è 138	Ü 154	¬ 170	 186	⌌ 202	ƒ 218	ú 234	· 250
B	1011	ï 139	ø 155	1/2 171	⌌ 187	⌌ 203	■ 219	ù 235	1 251
C	1100	î 140	£ 156	1/4 172	⌌ 188	ƒ 204	■ 220	ý 236	3 252
D	1101	ì 141	ø 157	i 173	¢ 189	= 205	ì 221	ý 237	2 253
E	1110	Ä 142	x 158	« 174	¥ 190	‡ 206	ì 222	— 238	■ 254
F	1111	Å 143	f 159	» 175	⌌ 191	α 207	■ 223	· 239	SP 255